

TOOLMAKER SOLUTIONS

Compax® PCD Tool Blanks and Inserts

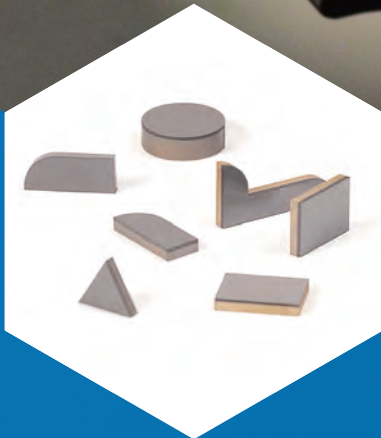

Polycrystalline diamond
blanks and cut shapes
for inserts and round tools



HYPERION
Materials & Technologies

COMPAX® PCD BENEFITS

The Compax diamond laminated blank design combines high hardness, abrasion resistance, low coefficient of friction and good impact resistance. The tungsten carbide substrate of the blank provides mechanical support to the diamond abrasive layer, increases its impact strength and also allows ease of braze attachment in finished tool fabrication. Compax PCD cutting blanks are most widely applied in machining non-ferrous and non-metallic materials. They have become a global industry standard for enhanced part quality and significant cost reductions in the overall production cycle.

- Higher material removal rates and improved cycle times, providing more parts per shift
- Cutting speeds significantly faster than those of conventional cutting tools
- Highly improved workpiece quality, excellent dimensional control, consistent surface finishes and reduced scrap
- Longer tool life resulting in increased machine up-time, providing greater production capacity without investing in new equipment.

MACHINING PARAMETER GUIDELINES

MATERIAL MACHINED	OPERATION	COMPAX PCD GRADE	SPEED (m/min)	FEED RATE (mm/rev)	DOC (mm)
Aluminum Alloy					
4 - 8% Si	Turning	1200P / 1600P / 1300P	900 - 3500	0.1 - 0.4	0.1 - 4.0
	Milling		1000 - 5000	0.1 - 0.3 mm/insert	0.1 - 3.0
9 - 14% Si	Turning	1300P / 1500P / 1600P / 1800P	600 - 2400	0.1 - 0.4	0.1 - 4.0
	Milling		700 - 3000	0.1 - 0.3 mm/insert	0.1 - 3.0
>14% Si	Turning	1300P / 1500P / 1800P	300 - 700	0.1 - 0.4	0.1 - 4.0
	Milling		400 - 900	0.1 - 0.3 mm/insert	0.1 - 3.0
Metal Matrix Composites					
Al (10 - 20%) SiC	Turning/Milling	1500P / 1800P	300 - 600	0.1 - 0.4	0.2 - 1.5
Copper Alloys					
Copper, Zinc, Brass	Turning/Milling	1600P / 1300P	400 - 1260	0.03 - 0.3	0.05 - 2.0
Tungsten Carbide 10-16% Co					
Unsintered ("green")	Turning	1500P / 1800P	50 - 200	0.1 - 0.4	0.1 - 1.0
Sintered	Turning	1500P / 1800P	20 - 40	0.1 - 0.25	0.1 - 1.0
Ceramics					
Unsintered ("green")	Turning	1500P / 1800P	50 - 200	0.1 - 0.2	0.1 - 1.0
Sintered	Turning	1500P / 1800P	20 - 40	0.1 - 0.2	0.1 - 0.5
Manufactured Wood					
MDF*	Routing	1600P / 1300P	1000 - 3650	0.1 - 0.4	0.1 - 4.0
Particle board	Sawing	1300P / 1500P	1500 - 4000	0.5 - 6.0	1.0 - 200
	Routing/Sawing	1800P	1000 - 4000	0.1 - 0.4	0.1 - 3.0
Plastics / Composites					
Carbon/Graphite	Turning/Milling	1300P / 1500P / 1800P	300 - 2000	0.05 - 0.3	0.1 - 3.0
Fiberglass/Plastics	Turning/Milling	1300P / 1500P / 1800P	200 - 1000	0.05 - 0.5	0.1 - 3.0
Fiberglass/Graphite	Turning/Milling	1800P	300 - 1000	0.1 - 0.4	0.1 - 3.0

* Medium density fiberboard (MDF)

* Special = if not standard layer

COMPAX® PCD FULL ROUND AND CUT PRODUCT AVAILABILITY CHART

Hyperion manufactures a complete line of high-quality sintered Compax PCD tool blanks. To achieve maximum productivity in tool manufacturing and machining applications, Hyperion supplies a wide variety of PCD grades and blank sizes and shapes.

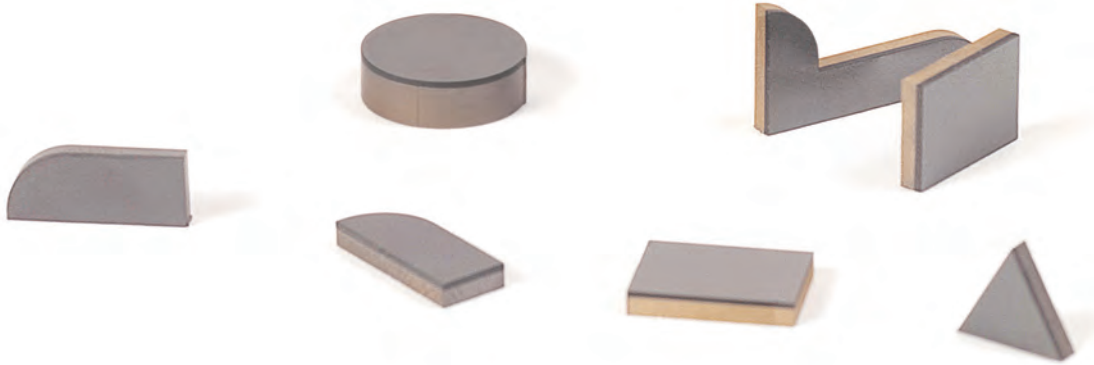

OVERALL THICKNESS RANGES FOR EACH GRADE AND LAYER OPTION

		PCD LAYER THICKNESS (mm)						
		0.2-0.45	0.4-0.8 or 0.4-0.65	0.6-0.85	0.65-1.0	0.8-1.2	1.2-1.6	
PCD GRADE	GP	NA	NA	NA	1.6-2.2	2.2-3.2	NA	Overall Thickness Range
	1200P	0.8-3.2	1.0-3.2	NA	NA	NA	NA	
	1600P	0.6-3.2	1.0-3.2	1.6-3.2	NA	NA	NA	
	1300P	0.6-3.2	1.0-3.2	1.6-3.2	NA	3.2-4.8	NA	
	1500P	0.8-3.2	1.0-3.2	1.6-3.2	NA	NA	NA	
	1800P	0.8-3.2	1.0-3.2	1.6-3.2	NA	NA	3.2-8.0	

Dimensions are in mm.

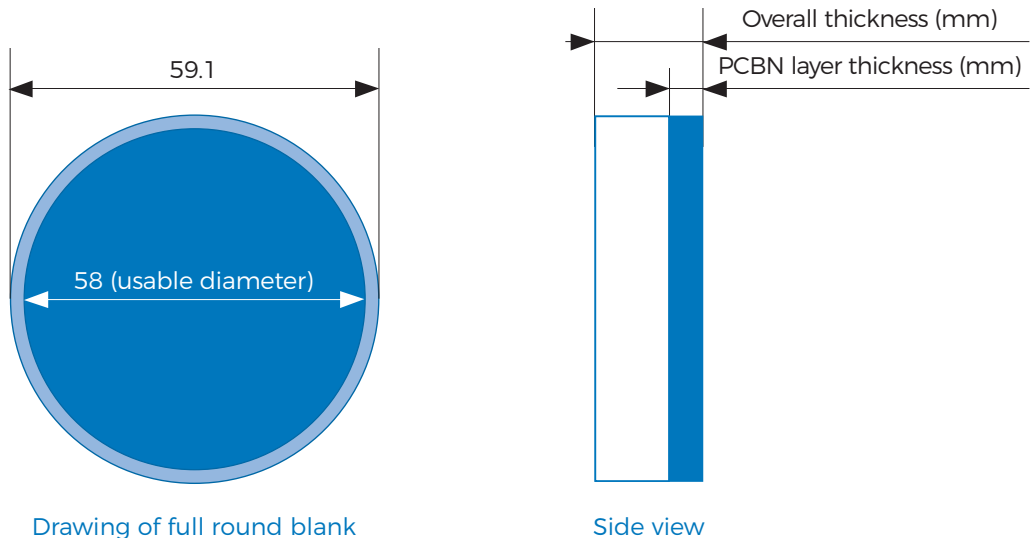

To see size and availability, please visit www.HyperionMT.com.

COMPAX® PCD ROUND TOOL SOLUTIONS

Compax veined PCD reduces grinding costs due to its unique design - a tungsten carbide substrate with polycrystalline diamonds sintered within the slots (veins) oriented along the helix angle. Because the diamond vein is sintered at high pressure and high temperature, the product offers a robust joint between the carbide and diamond while minimizing grinding costs for tool fabrication. The vein solution offers up to 30% better total cost of ownership when compared to traditional coated carbide solutions due to the ability to get multiple regrinds and significant tool life performance improvement. The nibs are designed specifically for use in machining of carbon fiber reinforced polymer (CFRP) and CFRP/metal stacks.

KEY FEATURES

- Wide range of drill diameters
- PCD oriented for minimal grinding
- Helix angle = 30°
- PCD average grain size = 9 µm
- PCD depth designed for reduced total cost of ownership.

DESCRIPTION	NIB DIAMETER (D)	NIB HEIGHT (H)	VEIN DEPTH (h)	FINISHED DRILL SIZE	
	(+/- 0.02 mm)	(+/- 0.10)	(+0.20/-0.10)	MIN	MAX
CDV3-N R3.8L11N11 3.3 00-09	3.8	11.0	3.3	2.7	3.6
CDV3-N R4.4L11N11 4.0 00-09	4.4	11.0	4.0	3.4	4.2
CDV3-N R5.3L11N11 4.4 00-09	5.3	11.0	4.4	4.0	5.1
CDV3-N R6.1L11N11 4.6 00-09	6.1	11.0	4.6	4.9	5.9
CDV3-N R7.1L11N11 4.7 00-09	7.1	11.0	4.7	5.7	6.9
CDV3-N R8.6L13N13 6.0 00-09	8.6	13.0	6.0	6.8	8.4
CDV3-N R10.0L13N13 6.4 00-09	10.0	13.0	6.4	8.2	9.8
CDV3-N R11.4L14N14 6.9 00-09	11.4	14.0	6.9	9.6	11.2
CDV3-N R12.9L14N14 7.6 00-09	12.9	14.0	7.6	11.0	12.7

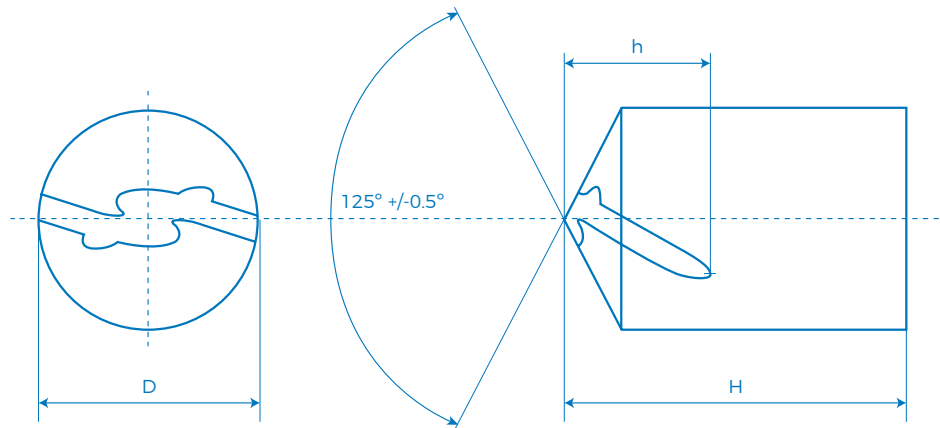

THICK COMPAX® PCD

Thick Compax diamond cut parts offer a tungsten carbide base with a thick PCD layer. This composition provides a product that boasts consistent and repeatable performance while greatly improving tool life. Thick Compax diamond cut parts are manufactured and sold as cylinders (without helical flutes) for manufacturing drills used in the aerospace industry and other industries that machine aluminum, titanium and composites.

GRAIN SIZE	PCD LAYER	OVERALL THICKNESS	DIAMETER	PCD LAYER TOLERANCE	OVERALL THICKNESS TOLERANCE	DIAMETER TOLERANCE
00 - 02 µm	2.5	13.0	1.5 - 8.5	+0.2 / -0.1	+/-0.10	+/-0.10
00 - 05 µm	2.5	13.0	1.5 - 8.5	+0.2 / -0.1	+/-0.10	+/-0.10
25 - 04 µm	2.5	13.0	1.5 - 8.5	+0.2 / -0.1	+/-0.10	+/-0.10
	4.0	13.0	1.5 - 8.5	+0.2 / -0.1	+/-0.10	+/-0.10

All measurements in mm unless otherwise noted.

OPTIMAL PERFORMANCE

- Machines combination of materials
- Enables tight tolerances
- Provides consistent quality
- Permits large diameter drills.

ORDERING EXAMPLE: 61594901 CDP1-N R7.5L13N13 2.5 00-02

HYPERION ITEM #	COMPAX DRILL PIN	DIAMETER	LENGTH	LAYER	PRODUCT
61594901	CDP1-N	R7.5	L13N13	2.5	00-02

GRADE	AVERAGE GRAIN SIZE
00-02	1,7 µm
00-05	5 µm
25-04	Bimodel 25 µm x 4 µm

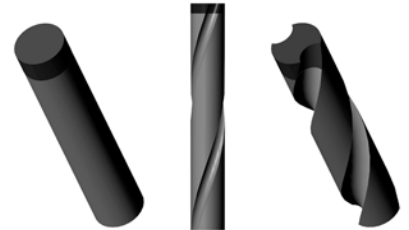
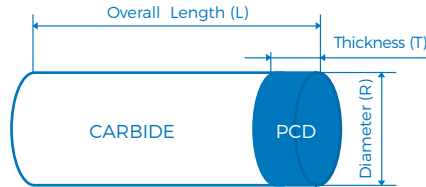

SOLID COMPAX® PCD

ORDERING EXAMPLE: 61595001 CDS90 W8.0H3.0T1.0 5U

HYPERION ITEM #	COMPAX DRILL PIN SOLID	WIDTH	HEIGHT	THICKNESS	GRAIN SIZE
61595001	CDS90	W8.0	H3.0	T1.0	5U

GRADE	AVERAGE GRAIN SIZE
5U	5 µm
25U	25 µm

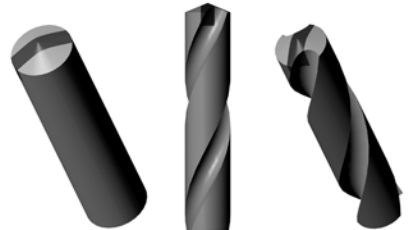
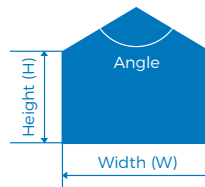

ORDERING EXAMPLE: 61595101 CDRS 360R8.0/5.0-5U

HYPERION ITEM #	COMPAX DRILL ROUND SOLID	DIAMETER	THICKNESS	GRAIN SIZE
61595101	CDRS	R8.0	5.0	5U

GRADE	AVERAGE GRAIN SIZE
5U	5 µm
25U	25 µm

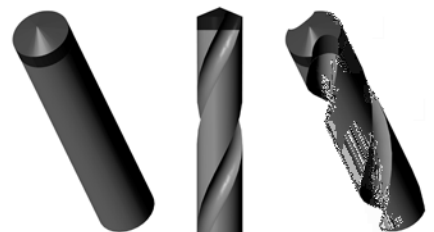
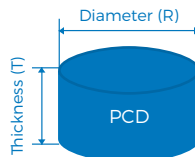

SERVICE SHOP





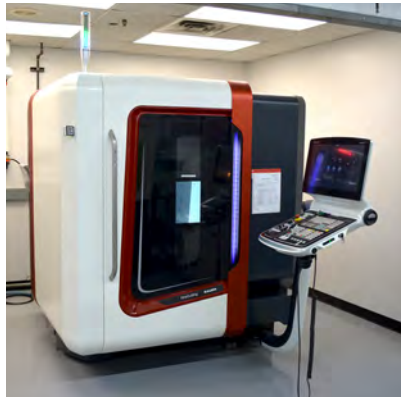

HYPERION UTILIZES THE LATEST IN EDM TECHNOLOGY

Our service shop is capable of performing precision cutting services:

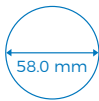
- Complete your cut order in **five** business days or less from the day the order is received.
- Each piece is cleaned and visually inspected to ensure you receive the highest level of quality and to minimize your internal processing time.
- Precision cutting of PCD blanks includes standard shapes, customer special shapes, through holes, tight tolerance, relief angles and carbide chamfers.

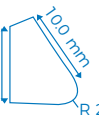

HYPERION NOMENCLATURE EXAMPLES

		LENGTH/ANGLE (mm/degree)	LEG LENGTH OR DIAMETER	OT	GRADE	SPECIAL*	DESCRIPTION
ROUND		360	58.0	1.6	13P		360R58.0/1.6-13P
HALF ROUND		180	10.0	2.4	15P		180P10.0/2.4-15P
PARTIAL		90	8.0	1.6	18P	0.2-0.45 PCD	90P8.0/1.6-18P 0.2-0.45 PCD
RECTANGLE		10.0	8.0	1.6	13P	0.6 MIN PCD	10.0L8.0/1.6-13P 0.6 MIN PCD
TRIANGLE		60	5.0	3.2	16P		60T5.0/3.2-16P
CUSTOMER SPECIAL				1.6	13P		DXXXXXX/1.6-13P
CHAMFER				1.6	13P	CHAMFER ON CARBIDE	DXXXXXX/1.6-13P CHF
HOLE		360	13	1.6	16P	HOLE 2 mm	360R13.0/1.6-16P HOLE 2mm

Standard cut product tolerance for PCD

Leg length = ± 0.1 Diameter = ± 0.1 Thermal zone (chip spec) ≤ 0.10 mm Angle = ± 1° degree Thickness = ± 0.05 mm

All dimensions in mm unless otherwise noted.

